



TECKWELL SHINEC PTE LTD
Steel Manufacturing & Wholesaler

creazio™
Creating Space



CZ-188-02
1740 x 1740 x 725



An office environment which combines prestige, and individuality, it motivates the user. Modern office design requires optimal use of space. Just all so, you will gain a decisive long Distance.



CZ-188-02
1540 × 1640 × 725



CZ-188-05
3140 × 1640 × 725



CZ-188-01
1540 × 600 × 725





CZ-188-04
1800 × 750 × 725



CZ-188-01



1400 × 700
1600 × 800
1800 × 900



1340 × 600 × 725
1540 × 600 × 725
1740 × 600 × 725



1223 × 410
1423 × 410
1623 × 410



1000 × 200
1200 × 200
1400 × 200

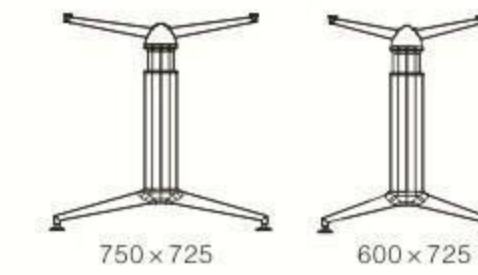

升降710-910



CZ-188-02



1600 × 800 + 900 × 650
1800 × 900 + 900 × 650
2000 × 1000 + 1000 × 650



1540 × 1640 × 725
1740 × 1740 × 725
1940 × 1940 × 725



1423 × 410
1623 × 410
1823 × 410



1200 × 200
1400 × 200
1600 × 200



CZ-188-03

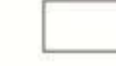

1800 × 900
2000 × 1000
2400 × 1200

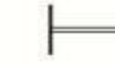

1000 × 750 × 725
1200 × 750 × 725
1400 × 750 × 725



800 × 200
1000 × 200
1200 × 200



800 × 200
1000 × 200
1200 × 200



CZ-188-04



1400 × 700 × 2
1400 × 700 × 3
1400 × 700 × 4



2740 × 600 × 725
4140 × 600 × 725
5540 × 600 × 725



1223 × 410 × 2
1223 × 410 × 3
1223 × 410 × 4



1000 × 200 × 2
1000 × 200 × 3
1000 × 200 × 4

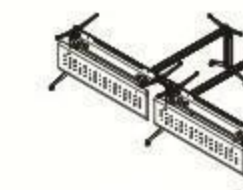

CZ-188-05



1600 × 800 + 900 × 650 × 2
1800 × 900 + 900 × 650 × 2



3140 × 1640 × 725
3540 × 1740 × 725



1423 × 410
1623 × 410

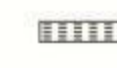

1200 × 200
1400 × 200

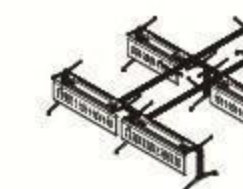

CZ-188-06



1400 × 700 + 700 × 600 × 4
1500 × 700 + 800 × 600 × 4



2740 × 2740 × 725
2940 × 2940 × 725



1100 × 350 × 2 700 × 350 × 2
1200 × 350 × 2 800 × 350 × 2



1000 × 200 × 2 600 × 200 × 2
1200 × 200 × 2 800 × 200 × 2



CZ-188-07



1400 × 700 + 700 × 600 × 4
1500 × 700 + 800 × 600 × 4
1600 × 700 + 900 × 600 × 4



2740 × 2740 × 725
2940 × 2940 × 725
3140 × 3140 × 725



1223 × 410 × 4
1323 × 410 × 4
1423 × 410 × 4



1000 × 200 × 4
1100 × 200 × 4
1200 × 200 × 4

Description:
Material: Aluminium
Surface Treatment: Powder Coated , Oxidation
Function: extension of all different kinds of tables



CZ-130-02
1800 × 900+900 × 550 × 725



CZ-130-01
1600 × 750 × 725



升降高度710~815



CZ-130-03
2800 × 1400 × 725



CZ-130-04
900 × 900 × 725



CZ-130-07
3000 × 3000 × 725



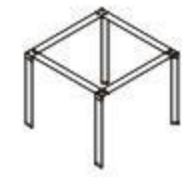

CZ-130-04

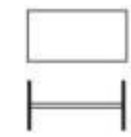

800 x 800 x 725
1000 x 1000 x 725
1200 x 1200 x 725



CZ-130-01



1400 x 700 x 725
1600 x 800 x 725
1800 x 900 x 725



1200 x 350
1400 x 350
1600 x 350



1000 x 200
1200 x 200
1400 x 200



CZ-130-02



1600 x 800 + 900 x 550
1800 x 900 + 900 x 550
2000 x 1000 + 1000 x 550



1400 x 350
1600 x 350
1800 x 350



1200 x 200
1400 x 200
1600 x 200



CZ-130-03



2400 x 1200 x 725
2800 x 1400 x 725
3200 x 1600 x 725



CZ-130-05



1400 x 700 x 2
1400 x 700 x 4
1400 x 700 x 6



1400 x 1400 x 725
2800 x 1400 x 725
4200 x 1400 x 725



CZ-130-06



L1400 x 1400 x 550
L1500 x 1500 x 550
L1600 x 1600 x 550



2800 x 1400 x 725
3000 x 1500 x 725
3200 x 1600 x 725



1200 x 350 x 2
1300 x 350 x 2
1400 x 350 x 2



1000 x 200 x 2
1100 x 200 x 2
1200 x 200 x 2



CZ-130-07



L1400 x 1400 x 600 x 4
L1500 x 1500 x 600 x 4
L1600 x 1600 x 600 x 4



2800 x 2800 x 725
3000 x 3000 x 725
3200 x 3200 x 725

Description:

Material: Aluminium

Surface Treatment: Powder Coated, Oxidation

Function: extension of all different kinds of tables



CZ-108-02

1560 x 1680 x 725





CZ-108-04
900 × 900 × 725











CZ-109-05-01
2960 × 1580 × 725



CZ-109-05
2760 × 1400 × 725



CZ-108 Series

	800 × 800 × 725 1000 × 1000 × 725 1200 × 1200 × 725				
	1600 × 800 1800 × 900	1560 × 800 1760 × 900	1300 × 380 1500 × 380	1200 × 200 1400 × 200	
	1600 × 800 + 900 × 550 1800 × 900 + 900 × 550 2000 × 1000 + 1000 × 650	1560 × 1680 × 725 1760 × 1760 × 725 1960 × 1960 × 725	1300 × 380 1500 × 380 1700 × 380	1200 × 200 1400 × 200 1600 × 200	
	1800 × 900 2000 × 1000	1760 × 900 × 725 1960 × 1000 × 725	1000 × 200 1000 × 200		
	1400 × 700 × 2 1400 × 700 × 4 1400 × 700 × 6	1360 × 1400 × 725 2760 × 1400 × 725 4160 × 1400 × 725	1000 × 200 × 2 1000 × 200 × 4 1000 × 200 × 6		
	L1500 × 700 + 900 × 550 × 2	1960 × 1580 × 725	1200 × 380 × 2	1200 × 200 × 2	
	L1500 × 700 + 900 × 550 × 4	2960 × 3000 × 725	1200 × 380 × 4	1200 × 200 × 4	
	L1500 × 1500 × 600 × 4 L1600 × 1600 × 600 × 4	2960 × 2960 × 725 3160 × 3160 × 725	1200 × 200 × 4 1300 × 200 × 4		

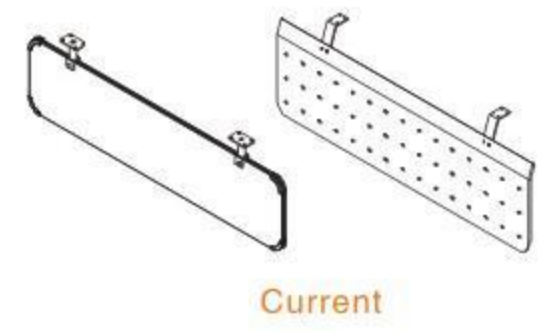

CZ-105-02
1560 × 1680 × 725

Description:
Material: Aluminium
Surface Treatment: Powder Coated, Oxidation
Function: extension of all different kinds of tables



CZ-105-04
900×900×725



CZ-106-02
1560×1680×725



CZ-105-05
2760×1400×725





CZ-107-02
1560 × 1680 × 725



CZ-107-01
1560 × 800 × 725



CZ-105-04
CZ-106-04
CZ-107-04

800 × 800
1000 × 1000
1200 × 1200

800 × 800 × 725
1000 × 1000 × 725
1200 × 1200 × 725



CZ-105-01
CZ-106-01
CZ-107-01

1400 × 700
1600 × 800
1800 × 900

1360 × 700 × 725
1560 × 800 × 725
1760 × 900 × 725

1100 × 380
1300 × 380
1500 × 380



CZ-105-02
CZ-106-02
CZ-107-02

1600 × 800 + 900 × 550
1800 × 900 + 900 × 550
2000 × 1000 + 1000 × 550

1560 × 1680 × 725
1760 × 1780 × 725
1960 × 1980 × 725

1300 × 380
1500 × 380
1700 × 380



CZ-105-03
CZ-106-03
CZ-107-03

1800 × 900
2000 × 1000

1760 × 900 × 725
1960 × 1000 × 725



CZ-105-05-01
CZ-106-05-01
CZ-107-05-01

1400 × 700 × 2
1400 × 700 × 3
1400 × 700 × 4

2760 × 700 × 725
4160 × 700 × 725
5560 × 700 × 725

1100 × 380 × 2
1100 × 380 × 3
1100 × 380 × 4



CZ-105-05
CZ-106-05
CZ-107-05

1400 × 700 × 4
1500 × 700 × 4
1600 × 700 × 4

1360 × 1400 × 725
2960 × 1400 × 725
3160 × 1400 × 725



CZ-105-07
CZ-106-07
CZ-107-07

L1600 × 1600 × 650 × 4

3160 × 3200 × 725

1300 × 380 × 4



CZ-105-08
CZ-106-08
CZ-107-08

L1400 × 1400 × 600 × 4
L1500 × 1500 × 600 × 4

2760 × 2760 × 725
2960 × 2960 × 725



CZ-105 Series



CZ-106 Series



CZ-107 Series

Description:
Material: Aluminium
Surface Treatment: Powder Coated, Oxidation
Function: extension of all different kinds of tables



升降高度710~815



CZ-112-05-01
1360 × 700 × 725



升降高度710~815



CZ-112-05
2760 × 1400 × 725



 CZ-131-04 800 × 800 × 725 1000 × 1000 × 725 1200 × 1200 × 725	 CZ-131-03 1400 × 700 × 2 1400 × 700 × 3 1400 × 700 × 4	 CZ-131-07 L1400 × 1400 × 600 × 4 L1500 × 1500 × 600 × 4 L1600 × 1600 × 600 × 4	 CZ-131-01 1400 × 700 × 725 1600 × 800 × 725 1800 × 900 × 725	 CZ-131-05 1120 × 400 1320 × 400 1520 × 400	 CZ-131-02 1600 × 800 + 900 × 550 1800 × 900 + 900 × 550 2000 × 1000 + 1000 × 550	 CZ-131-06 1400 × 1400 × 600 L1500 × 1500 × 600 L1600 × 1600 × 600	 2800 × 700 × 725 4200 × 700 × 725 5600 × 700 × 725	 2800 × 1400 × 725 4200 × 1400 × 725 5600 × 1400 × 725	 1120 × 400 1220 × 400 1320 × 400	 2800 × 2800 × 725 3000 × 3000 × 725 3200 × 3200 × 725
---	--	--	--	--	--	---	--	---	--	---



CZ-111-02
1560 × 1680 × 725



CZ-111-04
CZ-112-04



800 × 800
1000 × 1000
1200 × 1200



760 × 800 × 725
960 × 1000 × 725
1160 × 1200 × 725

升降高度710~815



CZ-111 Series

CZ-112 Series



CZ-111-01
CZ-112-01



1600 × 800
1800 × 900



1560 × 800
1760 × 900



1300 × 380
1500 × 380

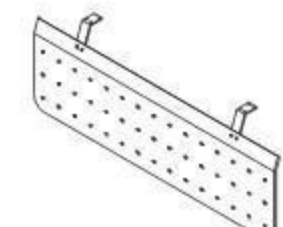

Current



CZ-111-02
CZ-112-02



1600 × 800 + 900 × 550
1800 × 900 + 900 × 550
2000 × 1000 + 1000 × 550



1560 × 1680 × 725
1760 × 1780 × 725
1960 × 1980 × 725



1300 × 380
1500 × 380
1700 × 380



CZ-111-03
CZ-112-03



1800 × 900
2000 × 1000



1760 × 900 × 725
1960 × 1000 × 725



CZ-111-05-01
CZ-112-05-01



L 1400 × 700 × 2



1360 × 700 × 725



1100 × 380 × 2



CZ-111-05
CZ-112-05



1400 × 700 × 2
1400 × 700 × 4
1400 × 700 × 6



1360 × 1400 × 725
2760 × 1400 × 725
4160 × 1400 × 725



CZ-111-07-01
CZ-112-07-01



L 1400 × 1400 × 700 × 4
L 1500 × 1500 × 700 × 4



2760 × 2800 × 725
2960 × 3000 × 725



1100 × 380 × 4
1200 × 380 × 4



CZ-111-08
CZ-112-08



L 1500 × 1500 × 600 × 4
L 1600 × 1600 × 600 × 4



2960 × 2960 × 725
3160 × 3160 × 725

Description:
Material: Aluminium
Surface Treatment: Powder Coated, Oxidation
Function: extension of all different kinds of tables



CZ-45X-01
1340 x 550 x 725



CZ-45X-02
1540 x 550 + 900 x 550 x 725

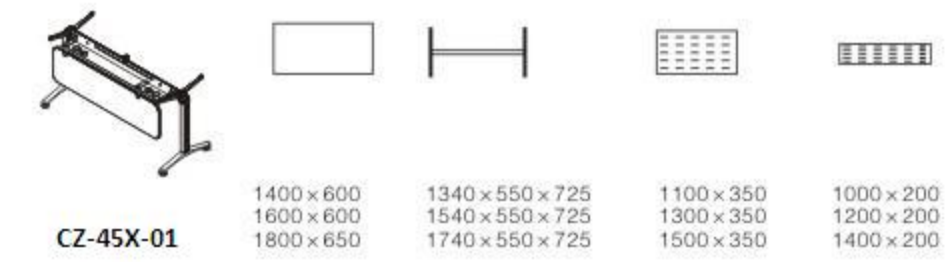

CZ-45X-01
1400 x 600
1600 x 600
1800 x 650
1340 x 550 x 725
1540 x 550 x 725
1740 x 550 x 725
1100 x 350
1300 x 350
1500 x 350
1000 x 200
1200 x 200
1400 x 200

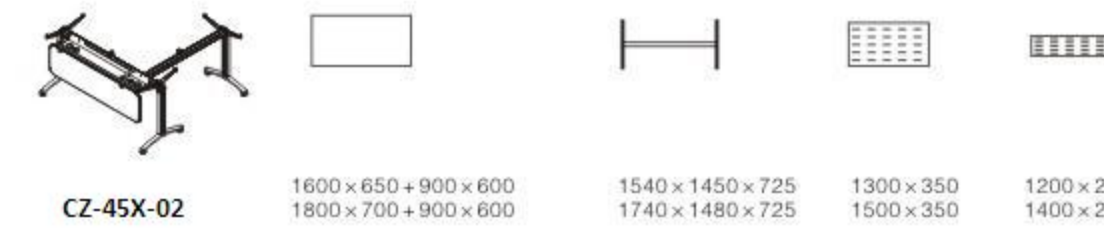

CZ-45X-02
1600 x 650 + 900 x 600
1800 x 700 + 900 x 600
1540 x 1450 x 725
1740 x 1480 x 725
1300 x 350
1500 x 350
1200 x 200
1400 x 200



CZ-45X-03
1400 x 600 x 2
1500 x 600 x 2
1600 x 600 x 2
2740 x 550 x 725
2940 x 550 x 725
3140 x 550 x 725
1100 x 350 x 2
1200 x 350 x 2
1300 x 350 x 2
1000 x 200 x 2
1200 x 200 x 2
1400 x 200 x 2

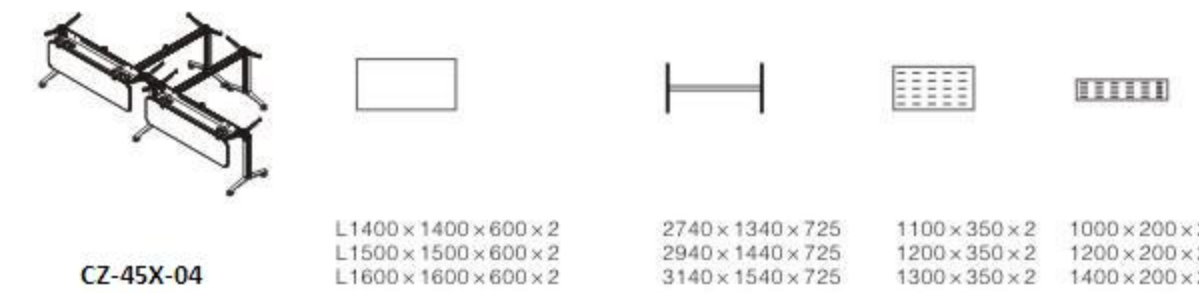

CZ-45X-04
L1400 x 1400 x 600 x 2
L1500 x 1500 x 600 x 2
L1600 x 1600 x 600 x 2
2740 x 1340 x 725
2940 x 1440 x 725
3140 x 1540 x 725
1100 x 350 x 2
1200 x 350 x 2
1300 x 350 x 2
1000 x 200 x 2
1200 x 200 x 2
1400 x 200 x 2

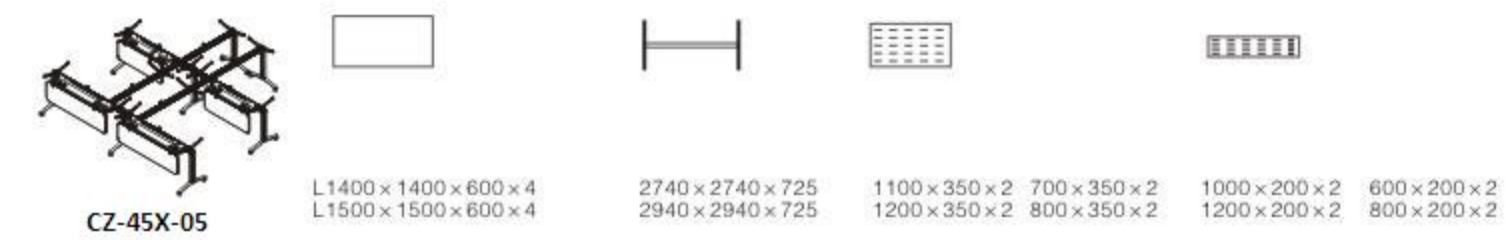

CZ-45X-05
L1400 x 1400 x 600 x 4
L1500 x 1500 x 600 x 4
2740 x 2740 x 725
2940 x 2940 x 725
1100 x 350 x 2
1200 x 350 x 2
700 x 350 x 2
800 x 350 x 2
1000 x 200 x 2
1200 x 200 x 2
600 x 200 x 2
800 x 200 x 2

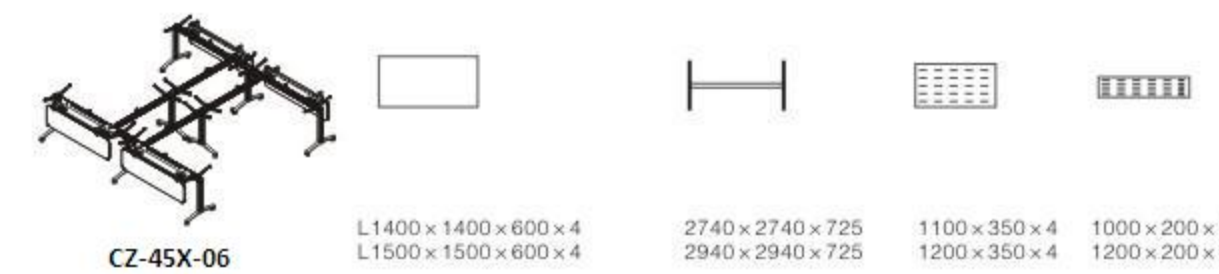

CZ-45X-06
L1400 x 1400 x 600 x 4
L1500 x 1500 x 600 x 4
2740 x 2740 x 725
2940 x 2940 x 725
1100 x 350 x 4
1200 x 350 x 4
1000 x 200 x 4
1200 x 200 x 4

Description:
Material: Aluminium
Surface Treatment: Powder Coated, Oxidation
Function: extension of all different kinds of tables



CZ-72-08
2800 × 2800 × 725
3000 × 3000 × 725
3200 × 3200 × 725

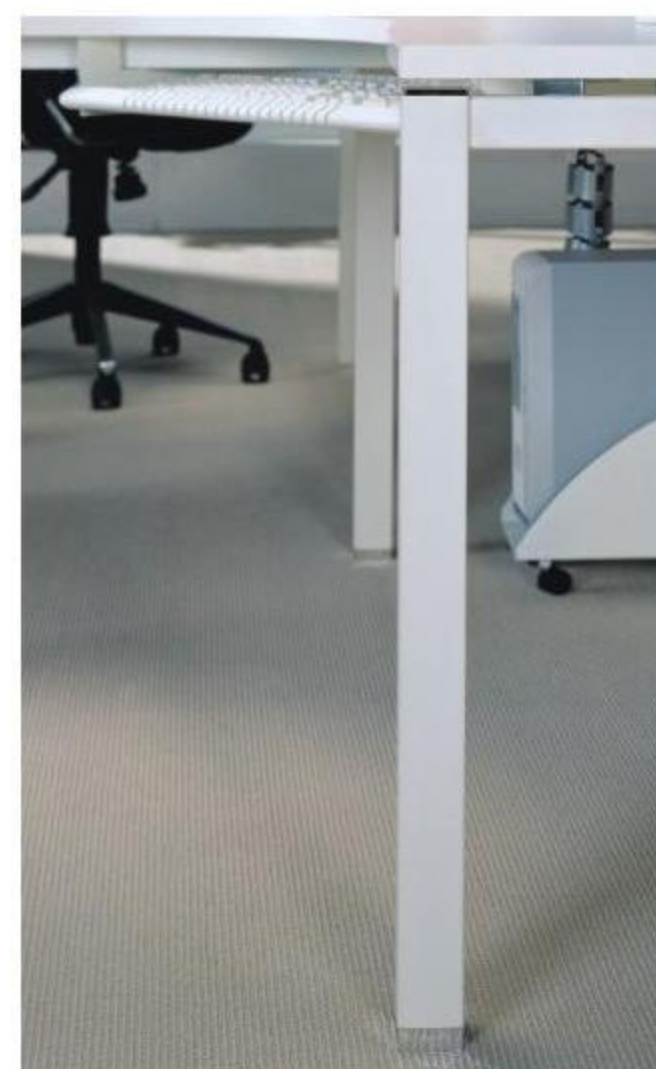

CZ-72-01
1400 × 700 × 725
1600 × 800 × 725
1800 × 900 × 725



DCOA-08-3
 □ 1600 × 1700
 ┆ 1350 ~ 1750 × 1480 ~ 1880 × 725
 ▤ 1250 ~ 1650 × 400
 ┆ 700 × 725
 ┆ 450 × 725

专利产品仿者必究
Patent products



DCOA-08-6
 □ L1200 × 1200 × 600 × 120° × 3
 ┆ 2070 ~ 2670 × 2070 ~ 2670 × 725 × 120°
 ┆ 900 × 725



DCOA-08-4
 □ 1500 × 750 × 2
 ┆ 2700 ~ 3500 × 700 × 725
 ┆ 700 × 725



专利产品仿者必究
Patent products

